

PRESTRESSED CONCRETE, INC.

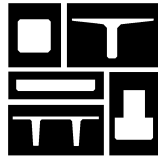

P.O. Box 311 • Newton, KS 67114
316-283-2277 • 316-283-2321(fax)

8'- 0" DOUBLE TEE
32" DEEP

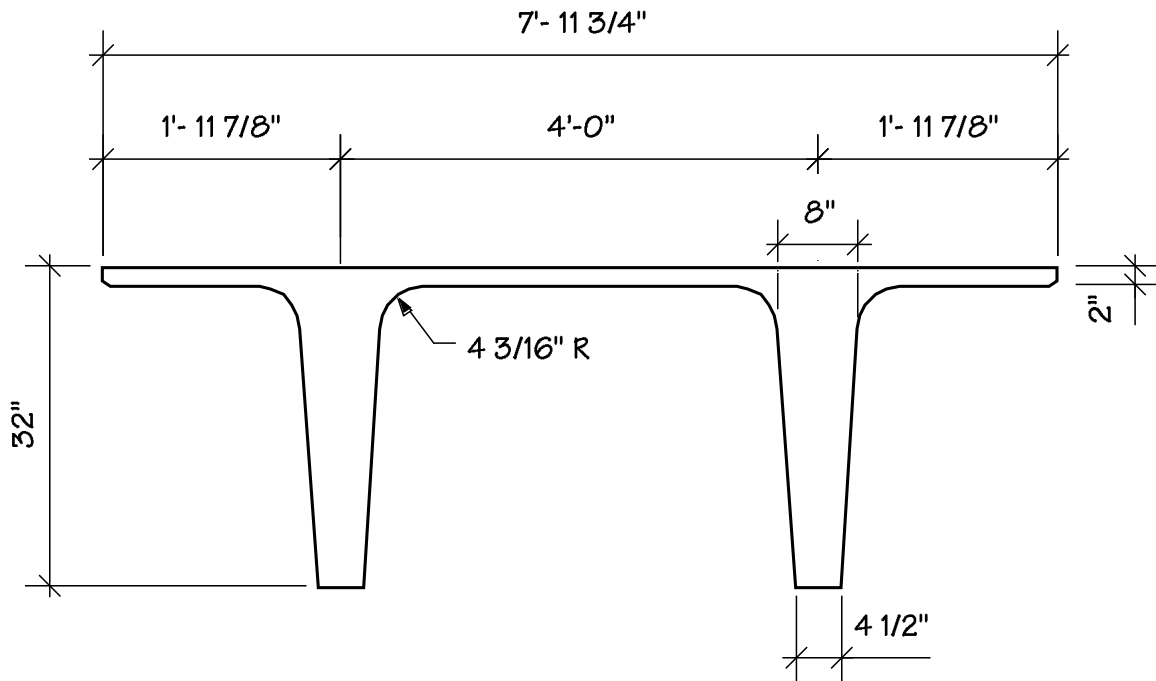

SECTION PROPERTIES

Wt. = 606 plf (485 plf)
A = 582 in²
Y_t = 10.46 in
Y_b = 21.54 in
S_b = 2,573 in³
S_t = 5,299 in³
I = 55,428 in⁴